

SÉRIE 3000

SO.3106.MTR



INTÉRIEUR EXTÉRIEUR



DIFFUSANT



FILTRANT



COMMANDE MOTORISÉE

STORE FILTRANT - DIFFUSANT
AVEC GUIDE POUR LA BASE
COMMANDE MOTORISÉE 220V



UNI EN 13561: 2009

Standard 1M
Dx/R

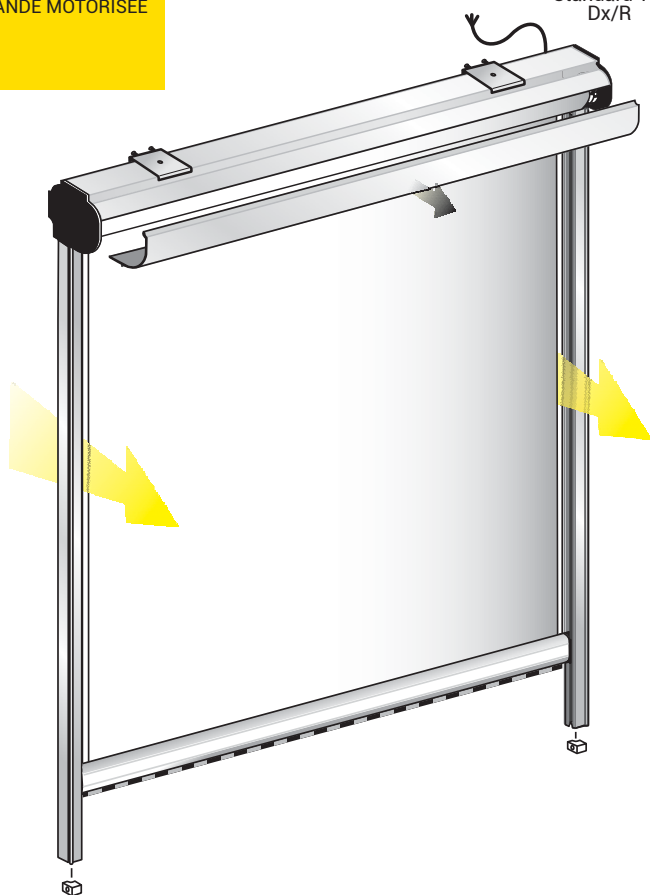

Caisson ouvrable et contrôlable

DIMENSION MINIMUM L 70cm.



Extérieur seulement avec MICROSCREEN - VETROSCREEN - TEKNOSCREEN - SUNCOVERSCREEN - BLACKOUT10 - VETROBLACKOUT

OPTIONS

STORE AVEC GUIDE E : IDÉAL EN AMBIANCE PUBLIQUE

STORE AVEC GUIDE N POUR INSTALLATION FRONTALE

SO.3107.MTR la paire

Réglable

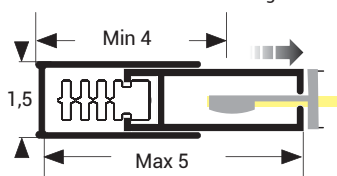

E

SO.3110.MTR la paire

Réglable

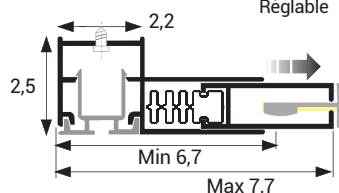

N

COULEUR ALUMINIUM

001 - anodisé ALU

229 - Bronze vernis

230 - Tête de maure vernis

201 - RAL 9010 Blanc

200 - RAL 1013 Crème

999 - RAL au choix : + 20% (+100€ net)

COULEUR ACCESSOIRES

Aluminium blanc/1013 BLANC

Toutes les autres couleurs NOIR

Tous RAL : Définir la couleur lors de la commande.

GUIDE STANDARD

U

Fourni avec un GUIDE en U pour une application interne.

OPTION :
CHAÎNETTE EN MÉTAL

COULEUR ALUMINIUM

COULEUR MANIVELLE

Aluminium Blanc/1013 BLANC

Aluminium argent GRIS

Tous les autres ral NOIR

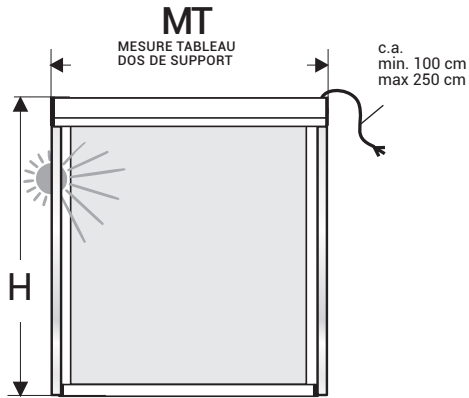

APPLICATIONS :



Standard : SORTIE 1M - DROIT.
Indiquer toute autre sortie sur la commande.

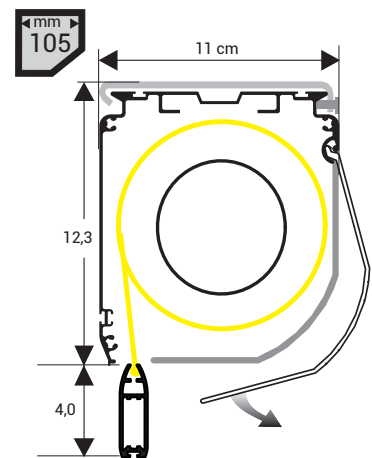
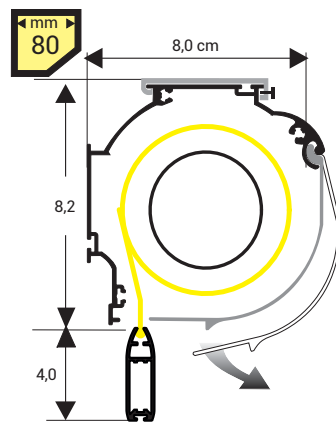
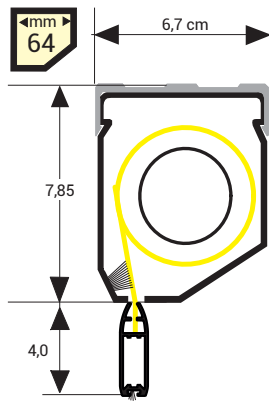

Cais. 64mm au plafond

Cais. 64mm frontal

Cais. 80mm au plafond

Cais. 80mm frontal

Cais. 105mm au plafond

Cais. 105mm frontal

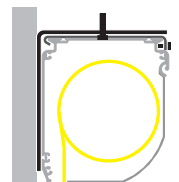
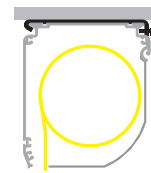
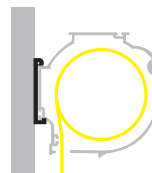
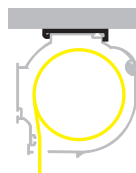
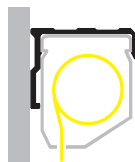

DONNÉES TECHNIQUES PAGE 196

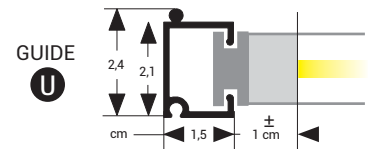

OPTIONS

INVERSEUR

TÉLÉCOMMANDE AUTOMATISME CENTRAL

MOTEUR RADIO

60072.

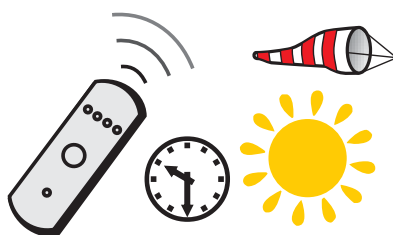
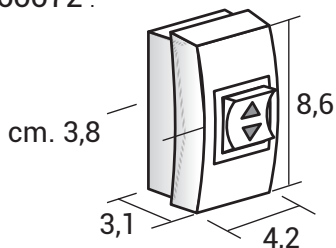

MN 0035

TÉLÉCOMMANDE 1 canal	60758	
TÉLÉCOMMANDE 4 canaux	60759	